



WIŚNIEWSKI

BROUGHT TO YOU BY



JDUK
Garage Door Systems

UniPro Sectional
Door Brochure

July 2022



GENERAL OVERVIEW 3-5

UNIPRO SECTIONAL DOORS 6-17

DOOR OPTIONS DESIGNS - TEXTURES 18-25

COLOUR OPTIONS 26-35

HANDLE OPTIONS 36-37

AUTOMATION & ACCESSORIES 38-41

INSPIRATION 42-49

TECHNICAL INFORMATION 50-63

www.jdukLtd.co.uk



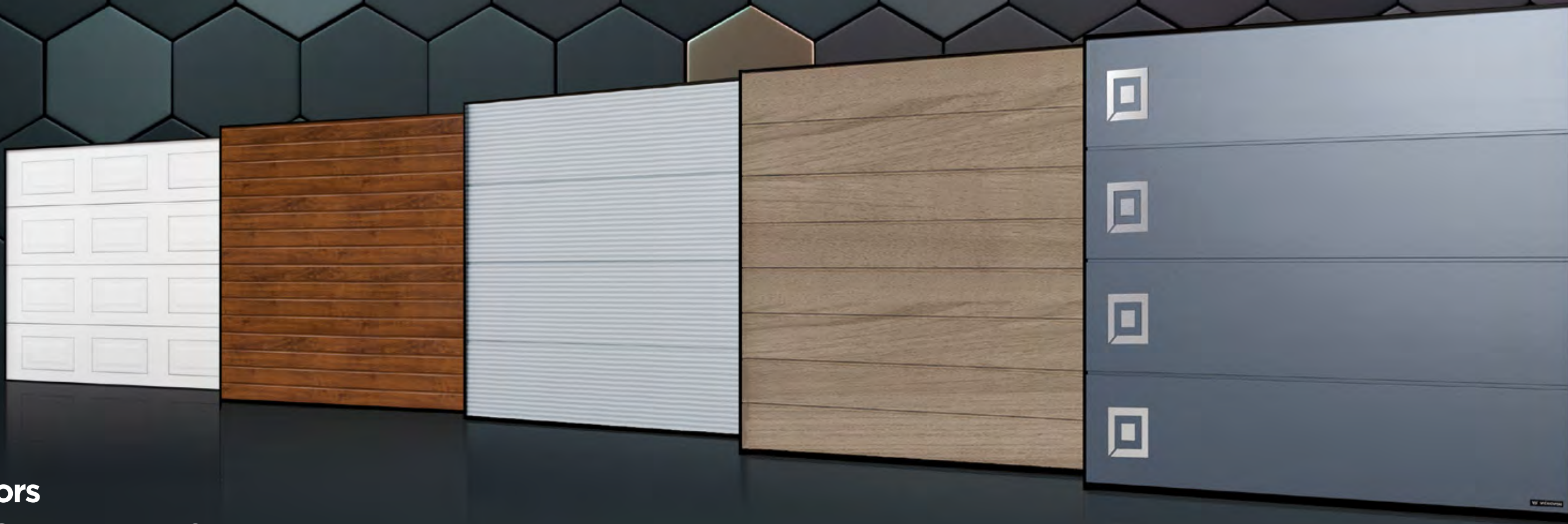

Welcome to the world of
WIŚNIEWSKI garage doors
brought to you by JDUK Garage Door Systems

Choose one of our sectional garage door solutions. This diversity is our response to the requirements of our customers. Let us surprise you with the multitude of options. We present to you the classy, safe, and functional sectional garage doors by WIŚNIEWSKI.

Why **WIŚNIEWSKI**?

For the last three decades, we have been working in accordance with the idea of the founder of the WIŚNIEWSKI brand, Andrzej Wiśniowski, who made it his goal to create innovative products addressing all of our customers' needs, providing many reasons to buy WIŚNIEWSKI products:

- **Side Sprung** available up to **5000mm** wide
- **Matching** profiles provided as standard
- **4 Panel** arrangement up to **2375mm** high
- **100mm headroom** including the tolerance required for the automation
- **Unique fascia** specifically designed for the UK
- **34 standard RAL** colours available
- **41 foiled** finishes available
- **Exclusive** - Home Inclusive colour range
- **Special** colours available on request, from Farrow & Ball to Little Greene Paint.



Perfection in **every detail**

UniPro

Always universal

Thanks to advanced technologies, proven materials and our own innovative technical thinking, we give our customers the certainty of a good choice. We have an integrated Management System, certified on the basis of the quality standard ISO 9001: 2008 and Occupational Health and Safety OHSAS 18001:2007. This is striving for continuous improvement of processes and products. The UniPro combines precision manufacturing and attention to detail with a vast range of designs, structures, colours, and decorative motifs. This lets you match the UniPro garage door with both modern and traditional buildings. Thanks to the multitude of design solutions, the UniPro garage door is the perfect choice for a new build or renovation,



STANDARD
CLASS

- **Side extension** springs available up to **5000mm** wide
- **Coloured profiles** supplied as **standard**
- **4 panel** arrangement up to **2375mm** high
- **Headroom** requirement including automation **100mm**
- **34 Standard RAL** colours to choose from
- Panel heat transfer coefficient **Up=0.48 W/m²K** ⁽¹⁾



UniPro

The UniPro sectional garage door is dedicated primarily to buildings with low lintel, with little space for torsion springs and narrow side clearance, making it impossible to use traditional solutions. It is also used for renovation, particularly with imperfectly finished garage openings. The UniPro features a specially designed profile system for frames positioned between the opening, which enables adjustment of the position of the door during installation. Thanks to its proven structure, it is a reliable solution that is installation friendly.



UNIVERSAL
INSTALLATION

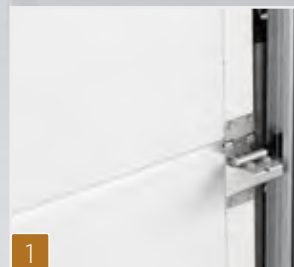

1 Side sprung up to **5000mm** wide

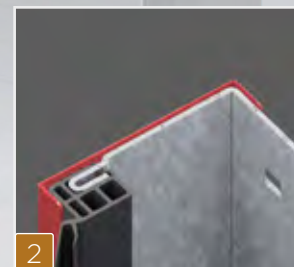

2 Matching profiles supplied as **standard**

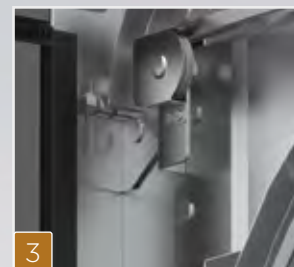

3 **Pre-installed** cable system

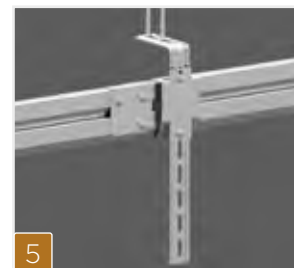

5 **Adjustable** ceiling fix

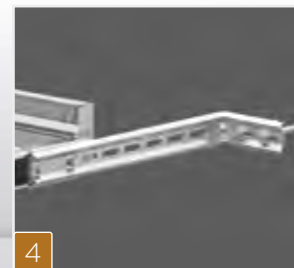

4 **Adjustable** rear side wall fix

Profile systems - **Supplied as standard**

Renovation is all about adapting the functionality of the current building to the needs of its users. The aim of the refurbishment is usually to improve the aesthetic quality of the building. Our profile systems let you install sectional garage doors in the garage opening regardless of the building conditions, even if the building has no lintel or side clearance. Enhance the functionality and the look of your garage with our profile solutions. Profiles to match all colours and foiled finishes are supplied as standard.



Functionality and reliability that lasts

We insist on implementing solutions that extend the life of our garage doors at the initial design stage. Our TÜV SÜD certificate guarantees that all the processes are strictly supervised along each stage, from the purchase of raw materials, through design and manufacture, up to the final product and customer support. It is a promise of the highest quality, safety, and comfort at each stage of use. A 10 year warranty covering the safe and reliable operation of the product is provided once registered to the extended care warranty programme. Would you like to find out more about controlling your home features using a smartphone? The smart CONNECTED technology brings WIŚNIEWSKI automatic sectional garage doors to the next level of product development, tailoring them to the requirements of modern customers. On the one hand, it lets you control the devices with your smartphone, and on the other, it gives you full control and lets you stay in touch with your home from any place in the world.



SAFETY



The **TÜV SÜD** certificate confirms that WIŚNIEWSKI operates in a systemic manner, which ensures that our processes are repeatable, our responsibility is transparent at each stage of meeting customers' demands, and that our processes are constantly being perfected.

Anti-burglary **safety kit RC2**

Your home is your castle. We understand it very well and support you in building a safe space for you and your family. The anti-burglary safety kit provides an even better protection for your home. Solutions designed by our engineers make the UniPro doors paired with the METRO drive unit almost impossible to force open. The mechanism locks the door automatically and protects it from being opened by unauthorised persons.

The RC2 level burglary protection is confirmed by a certificate from the widely recognised IFT Institute, so you can rest assured that everything that is important to you is well protected.



BURGLARY PROTECTION



Garage doors fitted with the RC2 burglary kit have a certificate issued by the IFT Rosenheim Institute (Germany) which confirms compliance with the DIN/TS 18194:2020 standard.



Available with UniPro sectional doors, complete with Somfy Metro automation

UNIPRO PROFILE SYSTEM

The UniPro profile system is our response to the needs of buildings intended for renovation. The structure is made of door frames adapted for installation in openings without the lintel or side clearance or with uneven wall surface. This structure comprises a fascia panel system in the same colour as the door leaf, which ensures great appearance without the need for further finishing works.

The UniPro profile system solves a multitude of potential issues that could occur during the replacement of the garage door. The structure is mounted directly to the existing surfaces with a system of angle bars which, paired with fascia panels, take over the functionality of the missing wall elements.



Installation To The Lintel



Behind The Lintel

Installation To The Frame



Behind The Opening



Under The Lintel



Between The Opening



In Front Of The Lintel



In Front Of The Opening



UNIVERSAL
INSTALLATION

Sectional door

Installation structure

It is a modern and functional solution enabling the installation of sectional garage doors regardless of the building conditions in your garage. It acts as a framework and replaces the missing elements of the lintel or the side area where the structural elements of the garage door are mounted. The structure is made of corrosion resistant galvanised steel and because fascia panels can be used in the door opening, the garage entrance maintains great appearance.



Renovation

Cladding panels

This solution makes it possible to match the front of the building with the design of the garage door curtain. A perfect solution for owners of multi-car garages who appreciate a uniform style of buildings with a garage integrated with the building structure.



Renovation

Fascia panels

The garage door opening can be damaged in the process of replacing the garage door. Fascia panels matching the door leaf colour can be used to cover up the damage or some less appealing building structure features.



Renovation fascia panel - option

Finishing thermal

Seal

Makes it possible to provide an aesthetic finish of the garage opening thermally insulated, for example, with a layer of polystyrene or Styrodur, by eliminating the clearance between the thermal insulation layer and the door leaf surface, which improves thermal insulation. Available for torsion doors only.

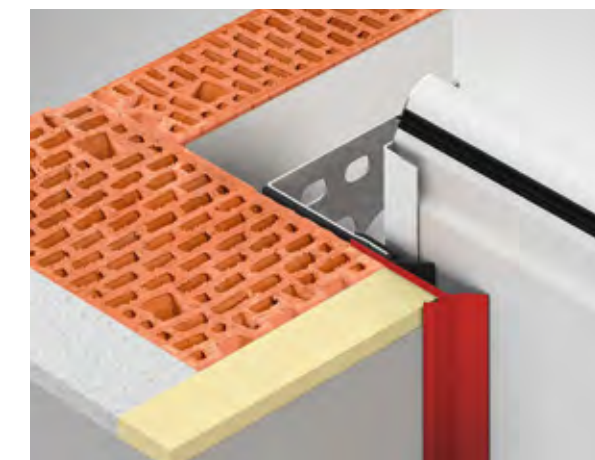

Finishing thermal seal - option

PANEL TEXTURES



Woodgrain

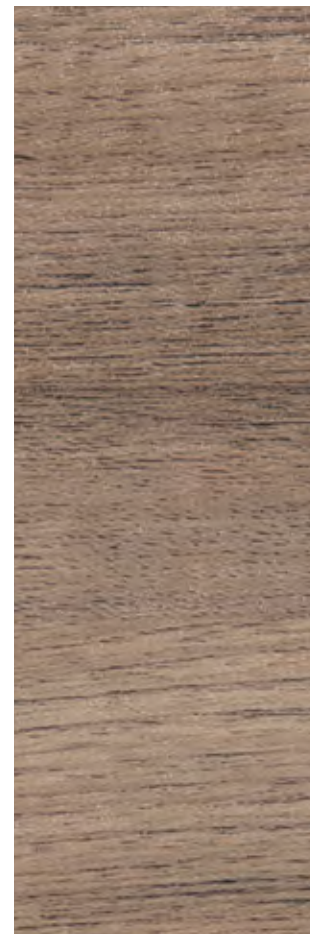

Smoothgrain

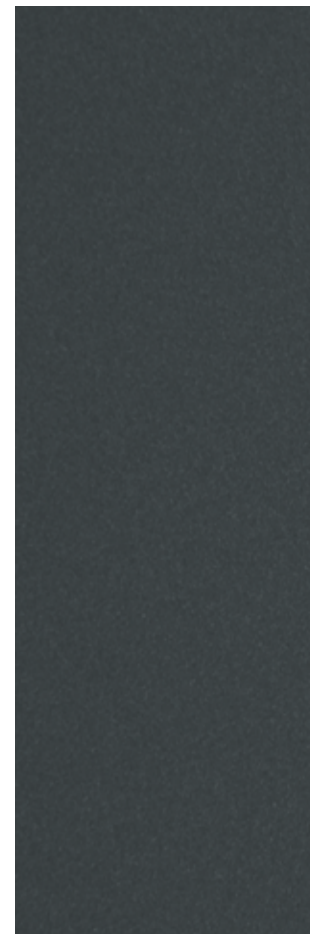

Silkline

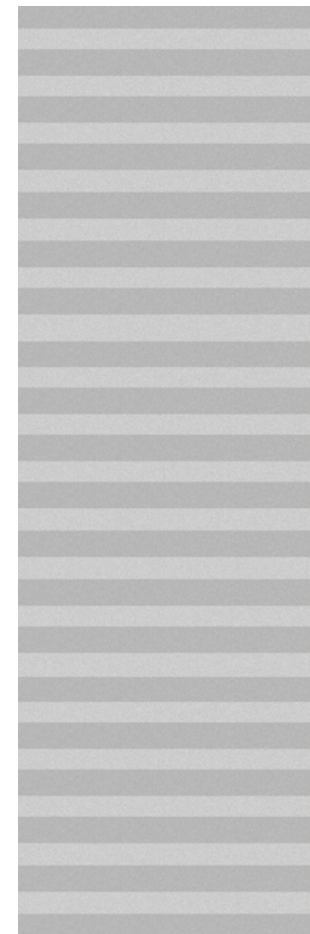

Microwave - Silkline



Sandgrain

PANEL DESIGNS

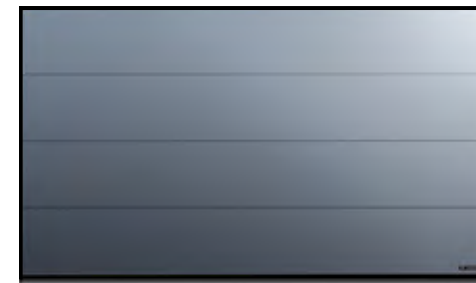

Panel design - L Ribbed

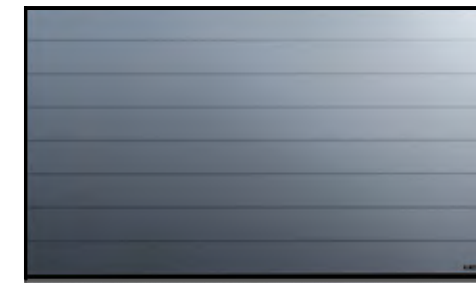

Panel design - M Ribbed



Panel design - S Ribbed

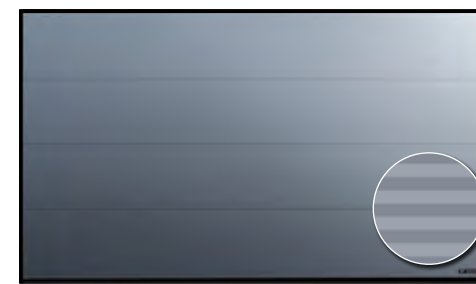

Panel design - Microwave



Panel design - Georgian

GLAZING OPTIONS



Rectangular Windows - Type A-1



Rectangular Windows - Type C-1



Rectangular Windows - Type E-1



Porthole Windows - Type O



Porthole Window - Type O-1A
Stainless Steel Frame



Porthole Window - Type O-2A
Stainless Steel Frame

GLAZING OPTIONS



Square Window - Type R-1A
Stainless Steel Frame

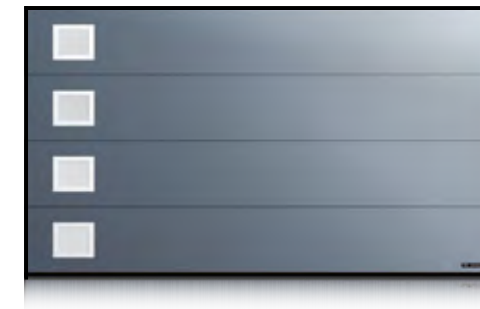

Square Window - Type R-2A
Stainless Steel Frame



Rectangular Sunrise
Window Type W3-1



Rectangular Sunrise Window
Type W4-1



Rectangular Sunrise Window
Type W5-1



Rectangular Sunrise Window
Type W6-1



DECORATIVE MOTIFS

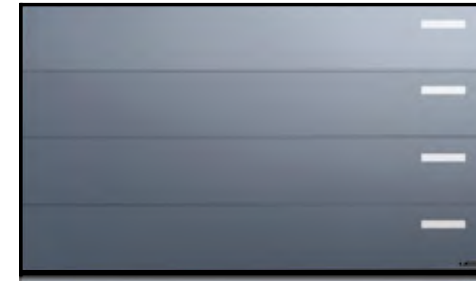

Decor Type Ap-1

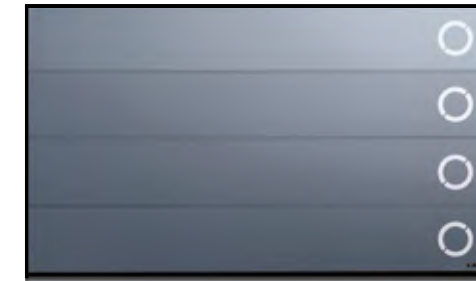

Decor Type Ap-2

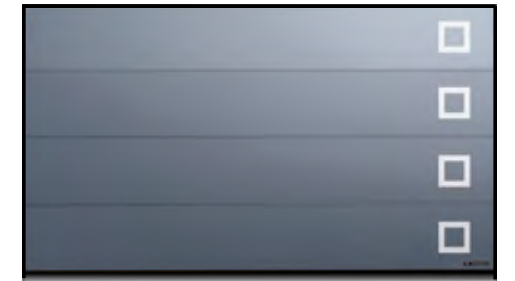

Decor Type Ap-3

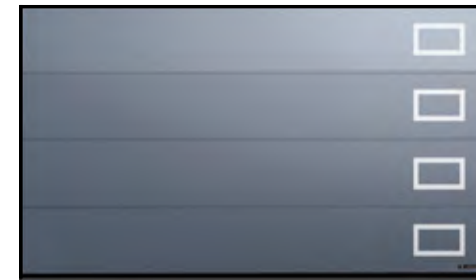

Decor Type Ap-4

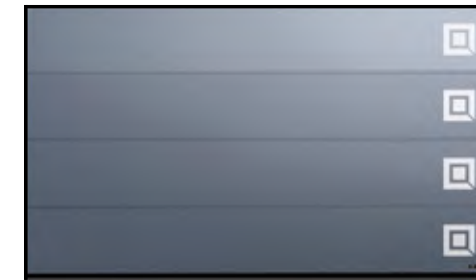

Decor Type Ap-5

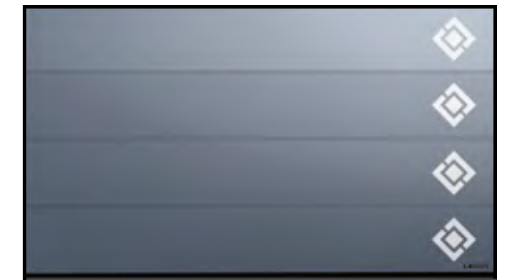

Decor Type Ap-6

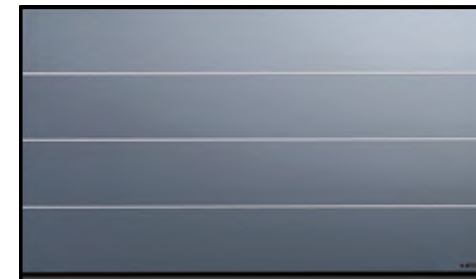

Decor Strip - L Ribbed Type Ap-7



Decor Strip - M Ribbed Type Ap-7

DOOR OPTIONS



Visual glazing - Available for doors up to 3000mm wide.

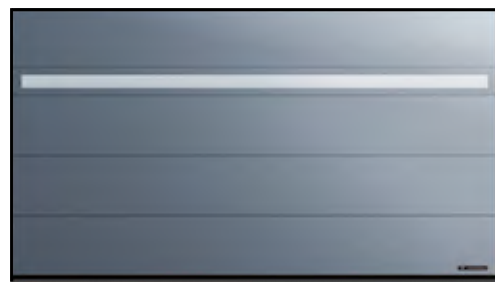

Horizon glazing - Available for doors up to 5250mm wide.

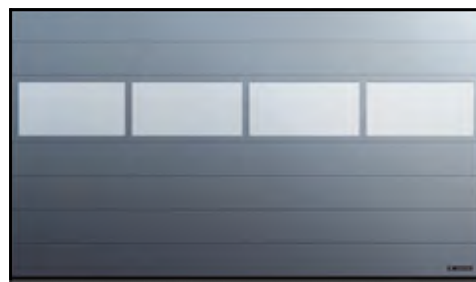

Panoramic glazing - Available for doors up to 4000mm wide



Wicket door



Ventilated panel - Perforated sheeting

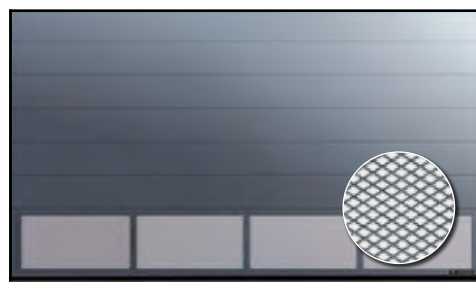

Ventilated panel - Expanded mesh panel

SIDE HINGED - SINGLE OR DOUBLE LEAF



L Ribbed Panel Design
Single or Double Leaf



M Ribbed Panel Design
Single or Double Leaf



S Ribbed Panel Design
Single or Double Leaf



Georgian Panel Design
Single or Double Leaf



Microwave Panel Design
Single or Double Leaf



Type A-1
Glazing



Type Ap-4
Decor

FORM AND FUNCTION

UniPro sectional garage doors by WIŚNIEWSKI are manufactured using 40mm thick insulated panel. All our panels are manufactured in the WIŚNIEWSKI facility using state-of-the-art technological lines, which ensure high quality and repeatability at each stage of the manufacturing process. High technical parameters and reliable corrosion protection are obtained thanks to the use of high grade, galvanised steel with paint or film coating. The stiff polyurethane foam core ensures optimum strength for the panels and improves their thermal insulation. Special solutions, such as the 5-layer sheet bending system ensures stable fastening of elements, which further increases the strength of our design.



1. Closed panel construction
2. Five sheet layers at the hinges
3. Panel joint seal
4. Polyurethane foam



THERMAL INSULATION

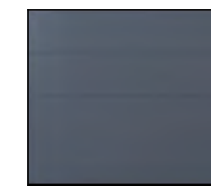
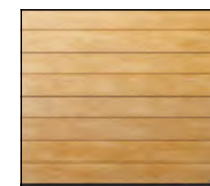
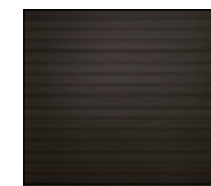
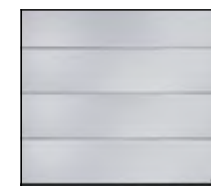

Microwave

S ribbed

M ribbed

L ribbed

Georgian

Woodgrain	—	RAL9016, Standard RAL, Special RAL, Non RAL Golden Oak & Walnut	RAL9016, Standard RAL, Special RAL, Non RAL Golden Oak & Walnut	RAL9016, Standard RAL, Special RAL, Non RAL Golden Oak & Walnut	RAL9016, Standard RAL, Special RAL, Non RAL & Golden Oak
Smoothgrain	—	—	41 film coatings	41 film coatings	—
Sandgrain	—	—	Anthracite	Anthracite	—
Silkline	RAL9016, Standard RAL, Special RAL & Non RAL	RAL9016, Standard RAL, Special RAL & Non RAL	RAL9016, Standard RAL, Special RAL & Non RAL	RAL9016, Standard RAL, Special RAL & Non RAL	—
Home Inclusive 2.0	—	16 colors	16 colors	16 colors	—

U thermal transmittance factor [W/m²K] for the UniPro sectional doors (40 [mm] panel)

		Door width in (mm)																
		2250	2375	2400	2500	2600	2750	3000	3250	3500	3750	4000	4250	4500	4750	5000	5250	5500
Door Height in (mm)	2000	1.3	1.3	1.3	1.3	1.3	1.3	1.3	1.3	1.3	1.3	1.3	1.3	1.3	1.3	1.2	1.2	1.2
	2100	1.3	1.3	1.3	1.3	1.3	1.3	1.3	1.3	1.3	1.3	1.3	1.2	1.2	1.2	1.2	1.2	1.2
	2125	1.3	1.3	1.3	1.3	1.3	1.3	1.3	1.3	1.3	1.3	1.2	1.2	1.2	1.2	1.2	1.2	1.2
	2200	1.3	1.3	1.3	1.3	1.3	1.3	1.3	1.2	1.2	1.2	1.2	1.2	1.2	1.2	1.2	1.2	1.2
	2250	1.3	1.3	1.3	1.3	1.3	1.3	1.2	1.2	1.2	1.2	1.2	1.2	1.2	1.2	1.2	1.2	1.2
	2375	1.3	1.3	1.3	1.3	1.3	1.3	1.2	1.2	1.2	1.2	1.2	1.2	1.2	1.2	1.2	1.2	1.2
	2500	1.3	1.3	1.3	1.3	1.3	1.3	1.2	1.2	1.2	1.2	1.2	1.2	1.2	1.2	1.2		
	2625	1.3	1.3	1.3	1.3	1.3	1.3	1.2	1.2	1.2	1.2	1.2						
	2750	1.3	1.3	1.3	1.3	1.3	1.3	1.2	1.2	1.2	1.2	1.2						
	2875	1.3	1.3	1.3	1.3	1.3	1.3	1.2	1.2	1.2	1.2							
3000	1.3	1.3	1.3	1.3	1.3	1.3	1.2	1.2	1.2									

AN ABUNDANCE OF COLOURS

Colour is the first feature our senses react to. We made sure that each of our customers can find the colour they are looking for. Our garage doors can be manufactured in RAL palette colours and in wood effect finishes. Together with our range of structures and extra decorative elements, this gives you hundreds of options for a totally bespoke design.



Standard RAL, special RAL and Non RAL colours available
 Wide selection of wood effect and coloured foils available pages 30-33
 Exclusive - Home Inclusive 2.0 available pages 34-35

COLOUR OPTIONS

One of the largest palettes of standard RAL colours available. Special RAL and non RAL colours are also available, whether your choice of colour is Farrow & Ball or Little Green please contact your dealer to arrange a sample.

TRAFFIC WHITE RAL 9016	PURE WHITE RAL 9010	CREAM RAL 9001	LIGHT IVORY RAL 1015	WHITE ALUMINIUM RAL 9006	GREY ALUMINIUM RAL 9007
FIR GREEN RAL 6009	MOSS GREEN RAL 6005	PALE GREEN RAL 6021	STEEL BLUE RAL 5011	GENTIAN BLUE RAL 5010	PIGEON BLUE RAL 5014
BURGUNDY RAL 3004	RUBY RED RAL 3003	FLAME RED RAL 3000	SEPIA BROWN RAL 8014	TERRA BROWN RAL 8028	NUT BROWN RAL 8011
LIGHT GREY RAL 7035	PEBBLE GREY RAL 7032	AGATE GREY RAL 7038	SILVER GREY RAL 7001	WINDOW GREY RAL 7040	STONE GREY RAL 7030
QUARTZ GREY RAL 7039	MOUSE GREY RAL 7005	BASALT GREY RAL 7012	SLATE GREY RAL 7015	GRAPHITE GREY RAL 7024	GRANITE GREY RAL 7026
ANTHRACITE GREY RAL 7016	SIGNAL BLACK RAL 9004	JET BLACK RAL 9005	GRAPHITE BLACK RAL 9011		

COLOURS ARE FOR REFERENCE PURPOSES ONLY
 PLEASE REQUEST A SAMPLE



L RIBBED	✓	✓	✓	✓	✓	✓	✓	✓	✓	✓	✓	✓	✓	✓	✓	✓	✓	✓	✓	✓	✓	✓	✓	✓	✓
M RIBBED	✓	✓	✓	✓	✓	✓	✓	✓	✓	✓	✓	✓	✓	✓	✓	✓	✓	✓	✓	✓	✓	✓	✓	✓	✓
S RIBBED																									
MICROWAVE																									
GEORGIAN																									

✓	✓	✓	✓	✓	✓	✓	✓	✓	✓	✓	✓	✓	✓	✓	✓	✓	✓	✓	✓	✓	✓	✓	✓	✓	✓
✓	✓	✓	✓	✓	✓	✓	✓	✓	✓	✓	✓	✓	✓	✓	✓	✓	✓	✓	✓	✓	✓	✓	✓	✓	✓

	Sheffield Oak Light F 456-3081 Smoothgrain	Sheffield oak grey F 436-3086 Smoothgrain	Brusch schwarzbraun F436-1023 smoothgrain	Earl platin 119500 smoothgrain	Black ulti-mat PX47097 smoothgrain	Woodec Turner Oak Malt F4703001 smoothgrain	Woodec Sheffield Oak Alpine F4703002 smoothgrain	Woodec Sheffield Oak Concrete F4703003 smoothgrain	Umbragrau F436-60657 smoothgrain	Fenstergrau F436-6066 smoothgrain	Cremeweiss F456-6001 smoothgrain	Anthrazitgrau F436-6003 smoothgrain	Dark grey silk 4367003 smoothgrain	Golden Oak 2178001-167 smoothgrain	Walnut 2178007-167 smoothgrain	Anthracite Quartz Mat F4701014 smoothgrain	Woodec Turner Oak Toffe F4703004 smoothgrain	Modern White (Painted finish based on RAL 9010) silklime	Modern White (Painted finish based on RAL 9010) woodgrain	Modern Black (Painted finish based on RAL9005) silklime	Modern Black (Painted finish based on RAL 9005) woodgrain
L RIBBED	✓	✓	✓	✓	✓	✓	✓	✓	✓	✓	✓	✓	✓	✓	✓	✓	✓	✓	✓	✓	✓
M RIBBED	✓	✓	✓	✓	✓	✓	✓	✓	✓	✓	✓	✓	✓	✓	✓	✓	✓	✓	✓	✓	✓
S RIBBED																		✓	✓	✓	✓
MICROWAVE																		✓	✓	✓	✓
GEORGIAN																					



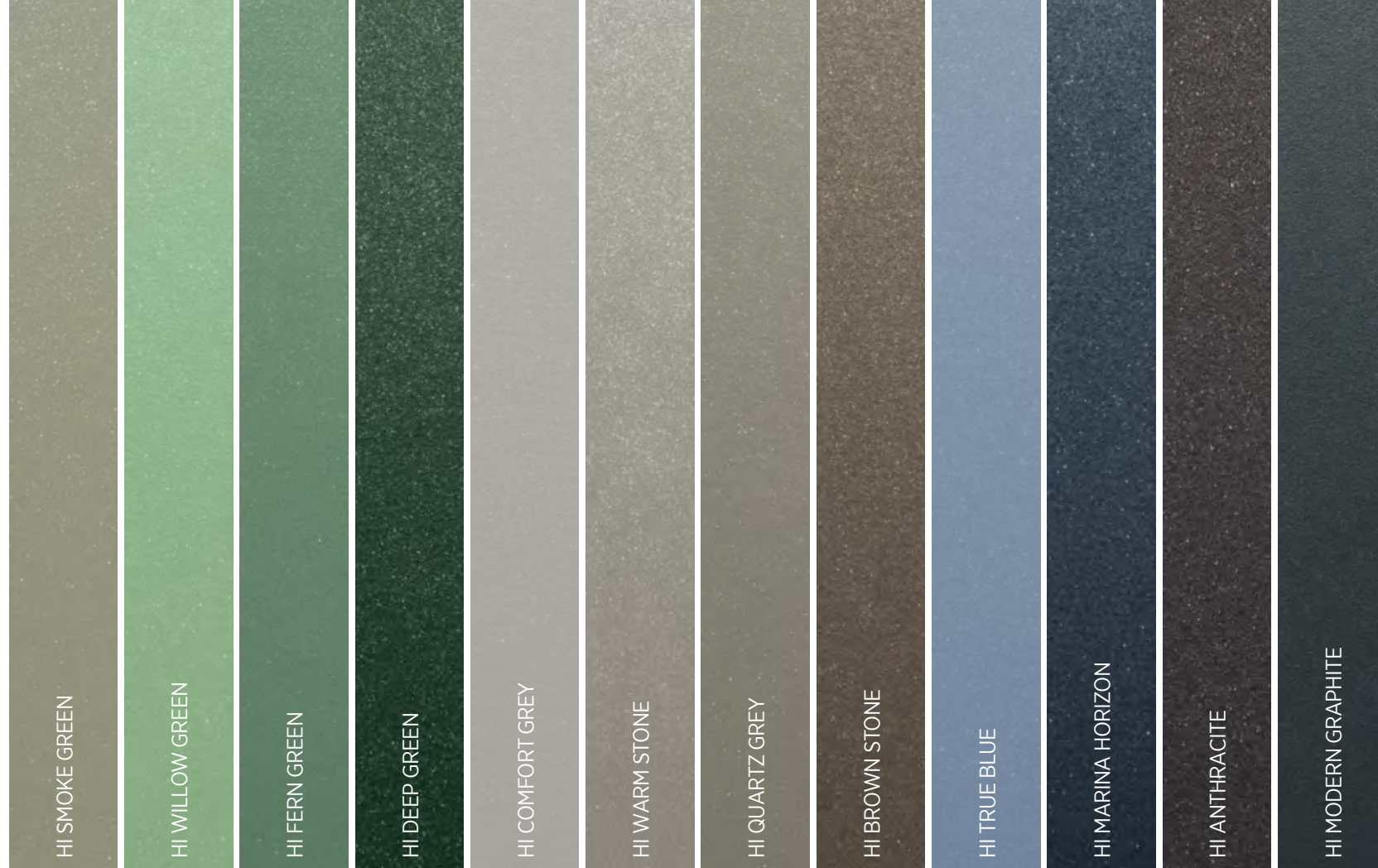

HI EARTH

HI STONE

HI STEEL

L RIBBED	✓	✓	✓	✓	✓	✓	✓	✓	✓	✓	✓
M RIBBED	✓	✓	✓	✓	✓	✓	✓	✓	✓	✓	✓
S RIBBED	✓	✓	✓	✓	✓	✓	✓	✓	✓	✓	✓
MICROWAVE											
GEORGIAN											



HI RUBY

	✓	✓	✓	✓
	✓	✓	✓	✓
	✓	✓	✓	✓



NEW
COLOURS
HOME
INCLUSIVE^{2.0}

THE HOME INCLUSIVE 2.0 COLOUR COLLECTION
Add exceptional character to your property thanks to the unique depth effect of HI 2.0 colours. Perfect for when you require a perfect colour match for your sectional door, insulated side hinged door and front entrance door.



HANDLE COLLECTION



KL-2 handle, colour: RAL 9006



KL-2 handle, colour: RAL 1036



KL-2 handle, colour: RAL 1035



KL-2 handle, colour: RAL 7048



KL-2 handle, colour: RAL 9016



KL-2 handle, colour: RAL 9005



KL-2 handle, colour: RAL 8014

METRO DRIVE

METRO is a new generation of drive units. It is a harmonious combination of power, beauty, and reliability, designed using state-of-the-art technology. It is the result of cooperation between WIŚNIOWSKI and Somfy, a leading global manufacturer of automation products and smart control solutions for home devices. The METRO drive features exceptional technical parameters in an enclosure designed according to the WIŚNIOWSKI design principles.





PULSAR
four-channel transmitter



METRO TECHNICAL DATA



		Metro RTS	Metro SMART io
Application	Sectional garage doors	•	•
	Up & over garage doors	•	•
Simple programming		•	•
Auto selection of operating parameters		•	•
Configurable		•	•
Display		•	—
Safety	Obstacle detection	•	•
	Photocells	•	•
Radio transmission	RTS	•	—
	io	—	•
Backup power supply		•	•
Cycle counter		•	— ⁽²⁾
Integrated signal light		•	•
Additional safeguard	Mechanical carriage lock	•	•
Stand-alone, additional external lamp		•	•
Recent fault logging		•	— ⁽²⁾
90° head adjustment		•	•
Steel rail with a chain or belt		•	•
Smart technologies	Ri-Co	•	•
	smartCONNECTED Box	—	•
	TaHoma Switch	• ⁽¹⁾	•
Garage ventilation feature		—	•
Remote control			
		PULSAR transmitter four channel	Smartphone app

⁽¹⁾ Control with no feedback.
⁽²⁾ Only with Set & Go

io homecontrol[®] is a modern, safe, and reliable radio technology by Somfy that lets you control your devices compatible with the smart home concept. Thanks to this technology, the drive unit not only receives commands from controllers, but it can also send feedback. The io-homecontrol technology makes it possible to connect the Metro SMART io drive to the TaHoma and smartCONNECTED Box system, which provides the drive with additional functions that connect the garage door with smart devices available in your home.

TREAT YOURSELF TO COMFORT AND SAFETY

- Control your garage door, gates, windows, and doors remotely
- Open garage doors and gates without touching your remote
- Manage your home via voice assistant

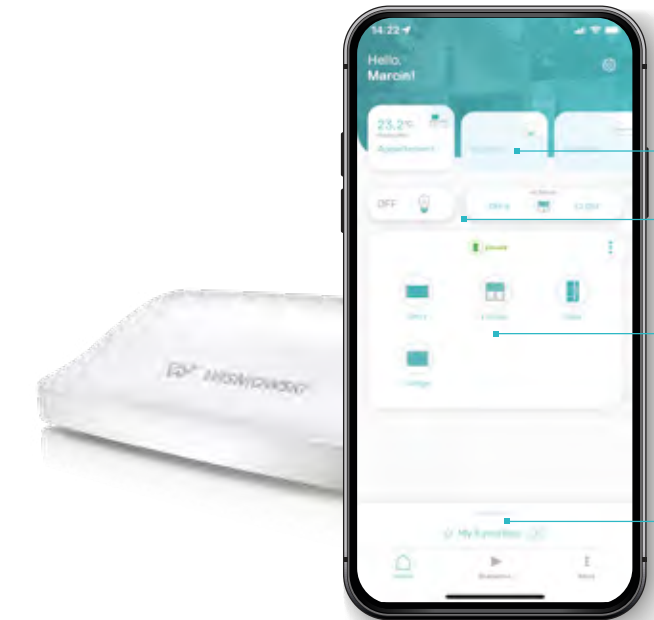

CREATE A ROOM in your home.

CONTROL GROUPS OF lights and roller shutters.

CONTROL INDIVIDUAL devices.

Create YOUR OWN OPERATION SCENARIOS.

The SmartCONNECTED technology brings WIŚNIOWSKI automatic sectional garage doors to the next level of product development, tailoring them to the requirements of increasingly demanding customers. On the one hand, it makes it possible to control the devices with a smartphone, and on the other, it gives the users full control and lets them stay in touch with their home from any place in the world. io-homecontrol[®] enables wireless connection of the Metro SMART io drive unit to the smart home system controlled by the WIŚNIOWSKI smartCONNECTED Box and Somfy TaHoma Switch central control units. Building a comprehensive smart home provides a number of benefits and additional features that enhance your comfort every single day.



AUTOMATION ACCESSORIES

Extra features offered by the automatic garage door equipment equal higher safety standards and more comfort.

Set&Go by Somfy is a device that guides the user through all the configuration steps of the io-home control automatic operating unit. The device includes an antenna and a PC application.



KEYPAD 2 RTS
The two-channel code keypad makes it possible to control both drive units and radio receivers. Thanks to radio communication, they can be installed in various locations



KEYPAD 2 io lets you control the io radio drives and can support up to two devices. The keypad is a flush-mounted wireless device and no cables are required for installation. The device is powered with a battery and features backlit keys.



RTS wall-mounted transmitter
The three-channel transmitter lets you control both your drive units and radio receivers thanks to radio communication, they can be installed in various locations



The external radio receiver lets you control the drive units using the Pulsar transmitter. It is a two channel device where you can program as many as 16 transmitters.



The mechanical carriage lock is an additional safeguard which increases garage door safety when mounted to the carriage.

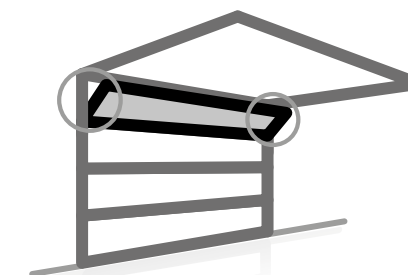

Garage ventilation feature is enabled by tilting the top panel without the need to lift the door. The bottom panel remains seated against the floor.



Warning lamp compatible with the METRO drives.



Battery backup connected to the METRO drive provides power for several cycles of emergency operation.



External code keypad - this single-channel device can be used to control the garage door with a code. For outdoor installation, requires cabling.



Photocells prevent uncontrolled door leaf movement when an obstacle is present within the clear passage.



UniPro | L Ribbed | HI Modern Graphite



UniPro | L Ribbed | RAL 3000 | Silkline
CREO | 345 | Sheffield Oak Light



UniPro | L Ribbed | RAL 7040 | Woodgrain



UniPro | M Ribbed | Anthracite | Sandgrain



UniPro | L Ribbed | HI Modern Graphite



UniPro | L Ribbed | Silkline | RAL7016



UniPro | L Ribbed | Anthracite | Sandgrain
DECO | 145 | RAL 7037 | Matt Structure



UniPro | L Ribbed | RAL 7016 | Silkline
Side Hinged Single Leaf | L Ribbed | RAL 7016

TECHNICAL INFORMATION

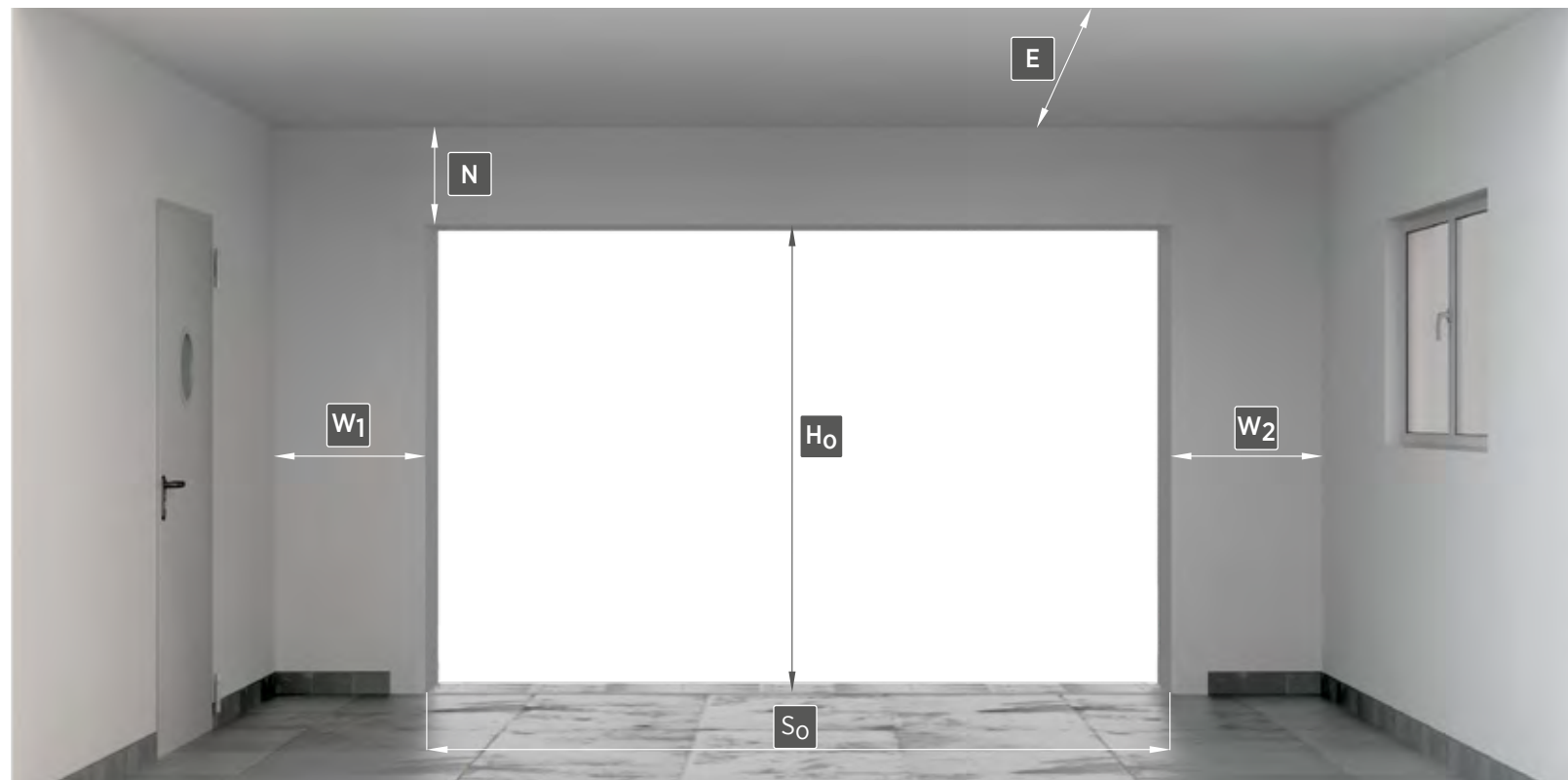

- S₀** - Opening width, ordering dimension
- H₀** - Opening Height, ordering dimension
- N** - Minimum required headroom

- W₁** - Minimum required side clearance
- W₂** - Minimum required side clearance
- E** - Minimum garage depth with clearance

TRACK SYSTEMS

- NP - Side Extension Springs
- Sp - Front Mount Torsion
- St - Rear Mount Torsion
- SpA - Inclined Tracks Front Mount Torsion
- StA - Inclined Tracks Rear Mount Torsion
- HL - High Lift Tracks Front Mount Torsion

UNIPRO PANEL DESIGNS

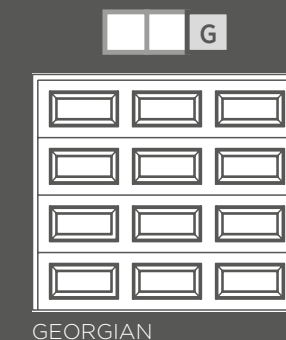
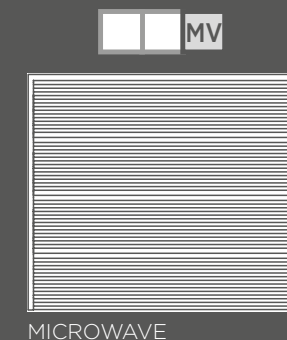
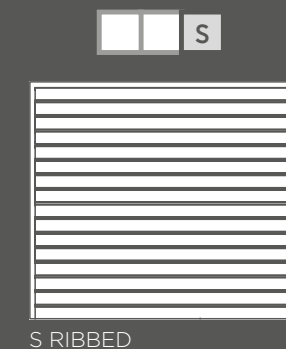
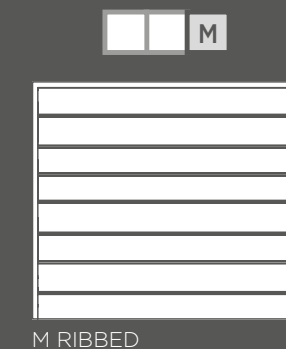

TECHNICAL INFORMATION

NP - SIDE EXTENSION

Minimum garage door dimensions: Extension Springs

$S_o = 1,500$ [mm] and $H_o = 1,800$ [mm] - garage doors type



$S_o = 1,500$ [mm] and $H_o = 1,900$ [mm] - garage doors type



$S_o = 2,230$ [mm] and $H_o = 1,990$ [mm] - garage doors type



$S_o \leq 1,750$ [mm] and $H_o \text{ max} = 2,500$ [mm], $1,750$ [mm] < $S_o \leq 2,000$ [mm] $H_o \text{ max} = 2,750$ [mm]

Available dimensions for - NP - Side Extension

Opening height ⁽¹⁾ (H_o) in [mm] up to	Opening width ⁽¹⁾ (S_o) in [mm] up to														
	2250	2375	2400	2500	2600	2750	3000	3250	3500	3750	4000	4250	4500	4750	5000
2000															
2100															
2125															
2200															
2250															
2375															
2500															
2625															
2750															
2875															
3000															

■ -Not applicable for doors with Sandgrain and Smoothgrain Foiled Texture

⁽¹⁾ - Ordering dimension.

INTERNAL DIMENSIONS - NP - SIDE EXTENSION

NP		Side Extension Springs
N _{min}	Manual	95 [mm]
	With Automation	95 [mm]
H _j	Manual + Catcher (standard)	$H_o - 60$ [mm]
	With Automation	$H_o - 60$ [mm]
W1, W2		95 [mm]
E _{min}	Manual	$H_o + 600$ [mm]
	With the METRO drive	$L_s + 410$ [mm]
L _s		2900mm for $H_o \leq 2250$; 3500mm for $H_o > 2250$ and $H_o \leq 2850$; 4500mm for $H_o > 2850$

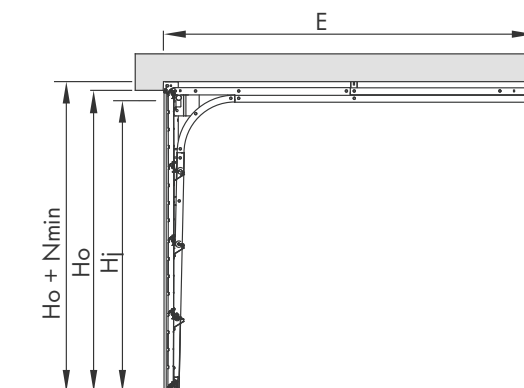

Tracks type:
Side Extension Springs

S_o - Opening width, ordering dimension.

S_j - Clear passage width after garage door installation.

H_o - Opening height, ordering dimension.

H_j - Clear passage height after garage door installation.

N - Minimum required lintel height.

W1 - Minimum required side clearance.

W2 - Minimum required side clearance.

E - Minimum garage depth with clearance under the ceiling.

L_s - Drive rail length.

TECHNICAL INFORMATION

Sp - FRONT MOUNT TORSION

Minimum garage door dimensions: Front Mount Torsion

$S_o = 1,500$ [mm] and $H_o = 1,800$ [mm] - garage doors type



$S_o = 1,500$ [mm] and $H_o = 1,900$ [mm] - garage doors type



$S_o = 2,230$ [mm] and $H_o = 1,990$ [mm] - garage doors type



Available dimensions for - Sp - Front Mount Torsion

Opening height ⁽¹⁾ (H_o) in [mm] up to	Opening width ⁽¹⁾ (S_o) in [mm] up to																
	2250	2375	2400	2500	2600	2750	3000	3250	3500	3750	4000	4250	4500	4750	5000	5500	6000
2000																	
2100																	
2125																	
2200																	
2250																	
2375																	
2500																	
2625																	
2750																	
2875																	
3000																	

⁽¹⁾ - Ordering dimension.

INTERNAL DIMENSIONS - Sp - FRONT MOUNT TORSION

		Front Mount Torsion
Nmin		= 220mm
Hj	Manual	$H_o - 160$ mm
	Manual + catcher	$H_o - 80$ mm
	With a drive unit	$H_o - 50$ mm
W1, W2		110mm
Emin	Manual	$H_o + 400$ mm
	With the METRO drive	$L_s + 410$ mm
Ls		2900mm for $H_o \leq 2250$; 3500mm for $H_o > 2250$ and $H_o \leq 2850$; 4500mm for $H_o > 2850$

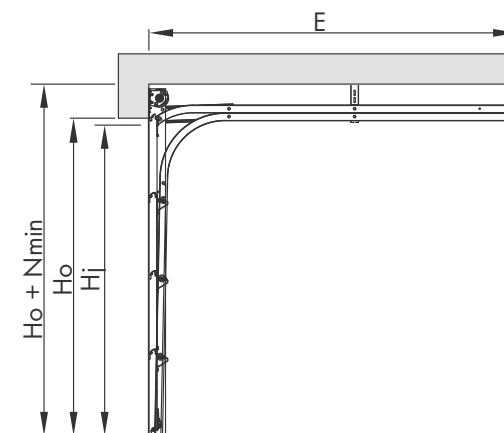

Tracks type:
Front Mount Torsion

S_o - Opening width, ordering dimension.

S_j - Clear passage width after garage door installation.

H_o - Opening height, ordering dimension.

H_j - Clear passage height after garage door installation.

N - Minimum required lintel height.

W1 - Minimum required side clearance.

W2 - Minimum required side clearance.

E - Minimum garage depth with clearance under the ceiling.

L_s - Drive rail length.

TECHNICAL INFORMATION

St - REAR MOUNT TORSION

Minimum garage door dimensions: Rear Mount Torsion

$S_o = 1,500$ [mm] and $H_o = 1,800$ [mm] - garage doors type

$S_o = 1,500$ [mm] and $H_o = 1,900$ [mm] - garage doors type

$S_o = 2,230$ [mm] and $H_o = 1,990$ [mm] - garage doors type

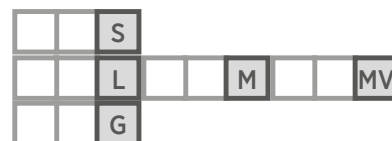

Available dimensions for - **St** - Rear Mount Torsion

Opening height ⁽¹⁾ (H_o) in [mm] up to	Opening width ⁽¹⁾ (S_o) in [mm] up to															
	2250	2375	2400	2500	2600	2750	3000	3250	3500	3750	4000	4250	4500	4750	5000	5500
2000																
2100																
2125																
2200																
2250																
2375																
2500																
2625																
2750																
2875																
3000																

⁽¹⁾ - Ordering dimension.

INTERNAL DIMENSIONS - **St** - REAR MOUNT TORSION

St		Rear Mount Torsion	
Nmin	Manual	100 [mm]	
	With Automation	140 [mm]	
Hj	Manual	$H_o - 160$ [mm]	
	Manual + catcher	$H_o - 90$ [mm]	
	With a drive unit	$H_o - 90$ [mm]	
W1, W2		110 [mm]	
Emin	Manual	$H_o + 750$ [mm]	
	With the METRO drive	$L_s + 410$ [mm]	
L_s		2900mm for $H_o \leq 2250$; 3500mm for $H_o > 2250$ and $H_o \leq 2850$; 4500mm for $H_o > 2850$	

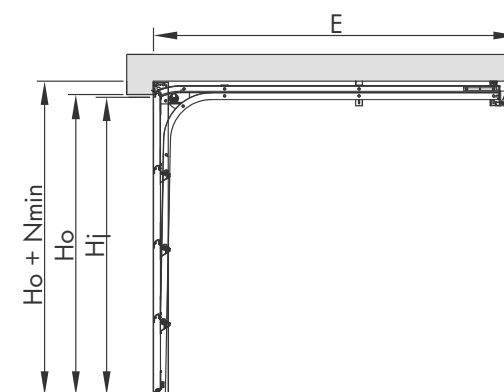

S_o - Opening width, ordering dimension.

S_j - Clear passage width after garage door installation.

H_o - Opening height, ordering dimension.

H_j - Clear passage height after garage door installation.

N - Minimum required lintel height.

W_1 - Minimum required side clearance.

W_2 - Minimum required side clearance.

E - Minimum garage depth with clearance under the ceiling.

L_s - Drive rail length.

TECHNICAL INFORMATION

SpA - INCLINED TRACKS FRONT MOUNT TORSION

Minimum garage door dimensions: Inclined Tracks Front Mount Torsion

$S_o = 1,500$ [mm] and $H_o = 1,800$ [mm] - garage doors type



$S_o = 1,500$ [mm] and $H_o = 1,900$ [mm] - garage doors type



$S_o = 2,230$ [mm] and $H_o = 1,990$ [mm] - garage doors type



Available dimensions for - **SpA**- Inclined Tracks Front Mount Torsion

Opening height ⁽¹⁾ (H_o) in [mm] up to	Opening width ⁽¹⁾ (S_o) in [mm] up to														
	2250	2375	2400	2500	2600	2750	3000	3250	3500	3750	4000	4250	4500	4750	5000
2000															
2100															
2125															
2200															
2250															
2375															
2500															
2625															

⁽¹⁾ - Ordering dimension.

INTERNAL DIMENSIONS - SpA- INCLINED TRACKS

SpA	Nmin		Hj		Sj	W1,W2
	manual	automatic	manual	automatic		
Degrees [°]	[mm]	[mm]	[mm]	[mm]	[mm]	[mm]
2 to 3	360	390	$H_o - 50$	$H_o - 20$	So - 40	110
4	350	380	$H_o - 50$	$H_o - 20$		
5 to 6	350	370	$H_o - 50$	$H_o - 20$		
7	350	360	$H_o - 50$	$H_o - 20$		
8 to 20	350	350	$H_o - 50$	$H_o - 20$		
Emin						
Automatic: $E_{min} = \cos(K_p) \times E_{min}'$						
Manual: $E_{min} = \cos(K_p) \times (H_o + 30 + 450)$						
H_o - opening height						
Emin' - value from the table, depending on the automatic operating unit and H_o						
K_p - inclination angle of the ceiling in relation to the floor						

Drive unit	Emin'	Height H_o
METRO	3,310	0 - 2,250
	3,910	2,251 - 2,850
	4,910	2,851 - 3,150

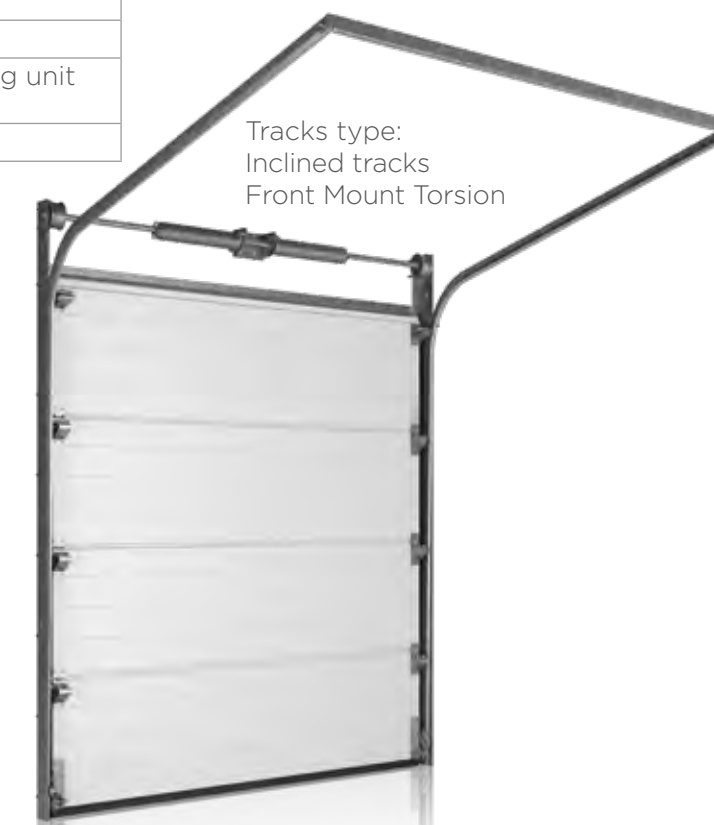
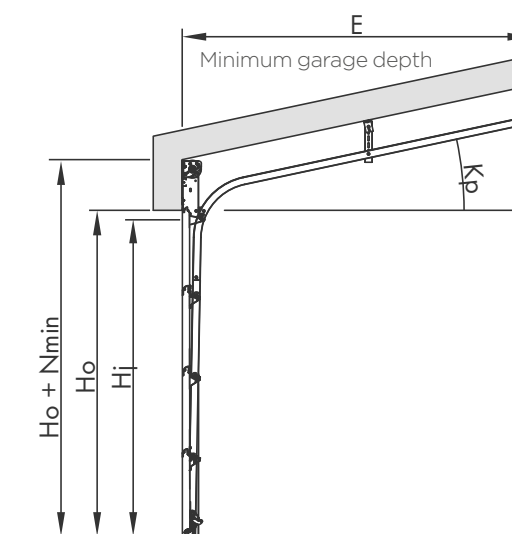

TECHNICAL INFORMATION

StA - INCLINED TRACKS REAR MOUNT TORSION

Minimum garage door dimensions: Inclined Tracks Rear Mount Torsion

$S_o = 1,500$ [mm] and $H_o = 1,800$ [mm] - garage doors type



$S_o = 1,500$ [mm] and $H_o = 1,900$ [mm] - garage doors type



$S_o = 2,230$ [mm] and $H_o = 1,990$ [mm] - garage doors type



Available dimensions for - **StA**- Inclined Tracks Rear Mount Torsion

Opening height ⁽¹⁾ (H_o) in [mm] up to	Opening width ⁽¹⁾ (S_o) in [mm] up to															
	2250	2375	2400	2500	2600	2750	3000	3250	3500	3750	4000	4250	4500	4750	5000	5500
2000																
2100																
2125																
2200																
2250																
2375																
2500																
2,625																

⁽¹⁾ - Ordering dimension.

INTERNAL DIMENSIONS - **StA**- INCLINED TRACKS

StA	N _{min}		H _j			S _j	W ₁ ,W ₂
	K _p	manual	automatic	manual	manual + catcher		
degrees [°]	[mm]	[mm]	[mm]	[mm]	[mm]	[mm]	[mm]
2	140	170	H _o - 100	H _o - 80	H _o - 70	S _o - 40	110
3	135	165	H _o - 110	H _o - 90	H _o - 70		
4	130	160	H _o - 120	H _o - 90	H _o - 70		
5	120	150	H _o - 130	H _o - 90	H _o - 70		
6	110	140	H _o - 140	H _o - 90	H _o - 70		
7	110	140	H _o - 140	H _o - 90	H _o - 70		
8	100	130	H _o - 140	-	H _o - 70		
9	100	120	H _o - 140	-	H _o - 70		
10	100	110	H _o - 140	-	H _o - 70		
11 to 20	100	100	H _o - 140	-	H _o - 60		

Drive unit	E _{min} '	Height H _o
METRO	3,310	0 - 2,250
	3,910	2,251 - 2,850
	4,910	2,851 - 3,150

E _{min}
Automatic: E _{min} =cos(K _p) x E _{min} '
Manual: E _{min} =cos(K _p) x (H _o +30+450)
H _o - opening height
E _{min} ' - value from the table, depending on the automatic operating unit and H _o
K _p - inclination angle of the ceiling in relation to the floor

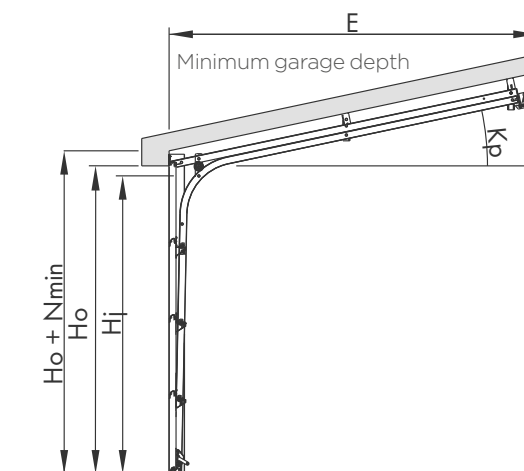

Tracks type:
Inclined tracks
Rear Mount Torsion

TECHNICAL INFORMATION

HL - HIGH LIFT TRACKS FRONT MOUNT TORSION

Minimum garage door dimensions: High Lift Tracks Front Mount Torsion

$S_o = 1,500$ [mm] and $H_o = 1955$ [mm] - garage doors type



$S_o = 2,230$ [mm] and $H_o = 2,040$ [mm] - garage doors type



Available dimensions for - HL - High Lift Tracks Front Mount Torsion

Opening height ⁽¹⁾ (H_o) in [mm] up to	Opening width ⁽¹⁾ (S_o) in [mm] up to															
	2250	2375	2400	2500	2600	2750	3000	3250	3500	3750	4000	4250	4500	4750	5000	5500
2000																
2100																
2125																
2200																
2250																
2375																
2500																
2625																
2750																
2,875																
3,000																

⁽¹⁾ - Ordering dimension.

INTERNAL DIMENSIONS - HL - HIGH LIFT TRACKS

HL		High lift torsion
Nmin	Manual	400 < N ≤ 1300
	With a drive unit	
Hj	Manual	$H_o - 20$ [mm]
	With a drive unit	
W1, W2		110 [mm]
Emin	Manual	$H_o - 0,8 \times N + 645$ [mm]
	With the METRO drive	3310mm for $H_o \leq 2080$; 3910mm for $2080 < H_o \leq 2680$; 4910mm for $H_o > 2680$

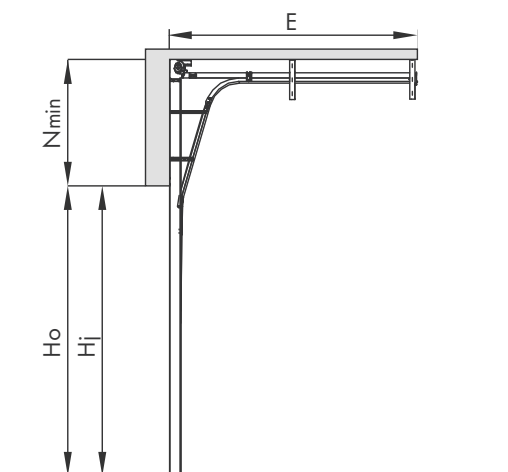

Tracks type:
High Lift Tracks
Front Mount

- S_o - Opening width, ordering dimension.
- S_j - Clear passage width after garage door installation.
- H_o - Opening height, ordering dimension.
- H_j - Clear passage height after garage door installation.
- N - Minimum required lintel height.
- W1 - Minimum required side clearance.
- W2 - Minimum required side clearance.
- E - Minimum garage depth with clearance under the ceiling.
- Ls - Drive rail length.

Coming soon...



JD (UK) Limited
Ravensthorpe Industrial Estate, Low Mill Lane.
Havelock Street, Ravensthorpe, Dewsbury. WF13 3LN
T 01924 472924 E sales@jdukLtd.co.uk www.jdukLtd.co.uk

